

**SEIKO**

**DIGITAL QUARTZ**

**Cal. A127A**

**PARTS LIST**

# Cal. A127A

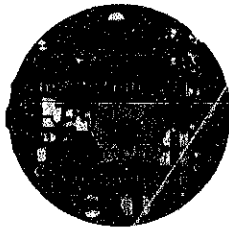
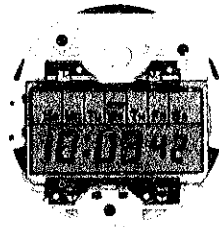

4001 862

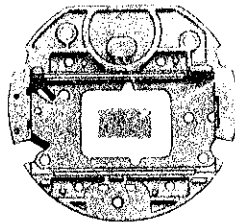

4033 862



4245 860



4313 860



☆4510 970



4521 550  
4521 551



4540 860



☆Maxell SR1130W

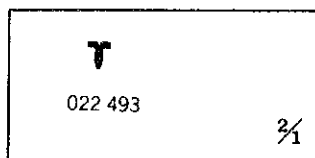

T  
022 493

$\frac{2}{1}$

# Cal. A127A

## Characteristics

Casing diameter:  $\phi$  30.1 mm  
 Maximum height: 6.5 mm without battery  
 Frequency of quartz crystal oscillator: 32,768 Hz (Hz = Hertz . . . . Cycle per second)  
 Time display: Digital Display System showing hour, minute, second and day of the week  
 Calendar display: Digital Display System showing month, date and day of the week  
 Stopwatch display: 12-hour Digital Display System showing hours, minutes and seconds (or minutes, seconds and 1/100 seconds up to 20 minutes measurement)  
 Counter display: Two counter displays enable to indicate from 1 to 9999 (1 counter) and from 1 to 99 (2 counters).  
 Display medium: Nematic Liquid Crystal, FE-Mode.  
 Time micro adjustor: Trimmer condenser system  
 Illuminating light: Illuminates all the digital displays in the dark by depressing the light button.  
 Battery life indicator: All the digits in the display begin flashing.

PART NO.	PART NAME	PART NO.	PART NAME
4001 862	Circuit block		
4033 862	Liquid crystal panel frame (with bulb)		
4245 860	Switch spring		
4313 860	Connector		
☆4510 970	Liquid crystal panel		
☆4510 971			
4521 550	Reflecting mirror (Silver)		
4521 551	Reflecting mirror (Gold)		
4540 860	Liquid crystal panel holder		
022 493	Liquid crystal panel holder screw		
☆Maxell SR1130W	Silver oxide battery		
☆U.C.C. 389			
☆Toshiba WG-10			

### Remarks:

#### Liquid crystal panel

☆4510 970 (Grey background) ..... Be sure that the combination between the color of panel cover and liquid crystal panel should be matched according to the "SEIKO Quartz Casing Parts List".  
 ☆4510 971 (Green background)

#### Battery

The applied battery for this calibre might be added the substitutive in the future. In that case, please refer to separate "BATTERIES FOR SEIKO QUARTZ WATCHES".

☆ ⇨ Please see remarks.

Part numbers in light letters are not shown in photos.

# TECHNICAL GUIDE

## SEIKO DIGITAL QUARTZ

CAL. A127A

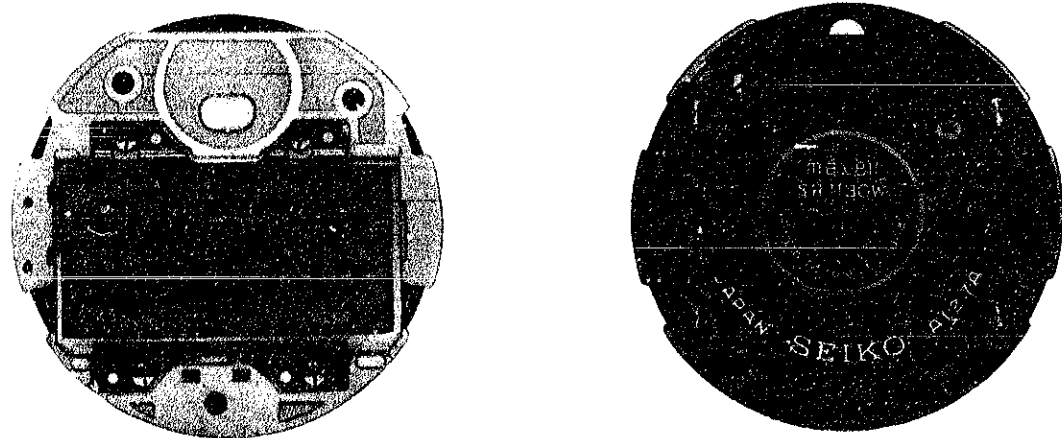

### CONTENTS

I. SPECIFICATIONS .....	1
II. DISASSEMBLING, REASSEMBLING AND LUBRICATING .....	2
1. Disassembling, reassembling and lubricating of the case .....	2
2. Disassembling and reassembling of the module .....	5
III. CHECKING AND ADJUSTMENT .....	7
1. Guide table for checking and adjustment .....	7
2. Relationship between the segment (Liquid Crystal Panel Electrode) and the C-MOS-LSI output terminal .....	8
3. Procedures for checking and adjustment .....	9
A : Check battery voltage .....	9
• How to check battery electrolyte leakage and repair .....	9
• Check pattern segment checking system .....	10
B : Check contact of C-MOS-LSI and liquid crystal panel .....	10
C : Check liquid crystal panel and circuit block .....	11
D : Check current consumption .....	12
E : Check accuracy .....	13
F : Check functioning and adjustment .....	13
G : Check bulb condition .....	14
H : Check conductivity of switch components .....	15

Calibre A127A

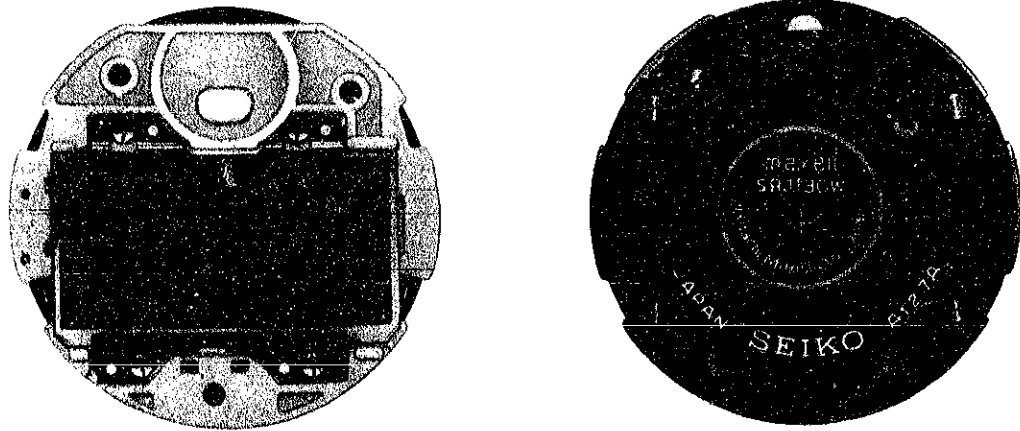

Module

## I. SPECIFICATIONS

Item	Cal. No. A127A
Display medium	Nematic Liquid Crystal, FEM (Field Effect Mode)
Display system	<p>Four-function changeover system with time, stopwatch, counter and time/calendar setting functions.</p> <ul style="list-style-type: none"> <li>● Time function: Digital display system showing hour, minute, second and day of the week. In the time function, calendar and elapsing time in the stopwatch function are displayed by depressing a button.</li> <li>Calendar: Digital display system showing month, date and day of the week.</li> <li>● Stopwatch function: 12-hour digital display system showing hour, minute, second and 1/100 second (The 1/100 second measurement is possible up to 20 minutes.)</li> <li>● Counter function: <ul style="list-style-type: none"> <li>Single counter . . . . . Counting up to 9999</li> <li>Twin counter . . . . . Counting up to 99 in two ways</li> </ul> </li> <li>● Time/calendar setting function: Time and calendar can be set to operate at a desired second, minute, hour (with "A" (for A.M.)/"P" (for P.M.) indication), date, month and day of the week.</li> </ul>
Additional mechanism	<ul style="list-style-type: none"> <li>● Battery life indicator (All the digits in the display start flashing when the battery life nears its end.)</li> <li>● Illuminating light</li> <li>● Pattern segment checking system</li> </ul>
Crystal oscillator	32,768 Hz (Hz = Hertz . . . . . Cycle per second)
Loss/gain	<p>Loss/gain at normal temperature range</p> <p>Monthly rate : less than 15 seconds</p> <p>(Annual rate : less than 3 minutes)</p>
Casing diameter	φ30.1 mm
Height	6.5 mm without battery
Operational temperature range	-10°C ~ +60°C (14°F ~ 140°F)
Regulation system	Trimmer condenser
Battery power	<p>Silver oxide battery: U.C.C. 389, Maxell SR1130W or Toshiba WG-10</p> <p>Battery life is approximately 3 years.</p> <p>Voltage: 1.55 V</p>
IC (Integrated Circuit)	C-MOS-LSI . . . . . 1 unit

## II. DISASSEMBLING, REASSEMBLING AND LUBRICATING

### 1. Disassembling and reassembling of the case

Disassembling procedures Figs.:

① ~ ⑥

Reassembling procedures Figs.:

⑥ ~ ①

Lubricating: Silicone grease (500,000 c.s.)  
Normal quantity ●

Ex.) Case No. A127-5029 **A**

#### Glass portion

It is not necessary to disassemble the glass except when it is replaced. (See page 4 for handling.)

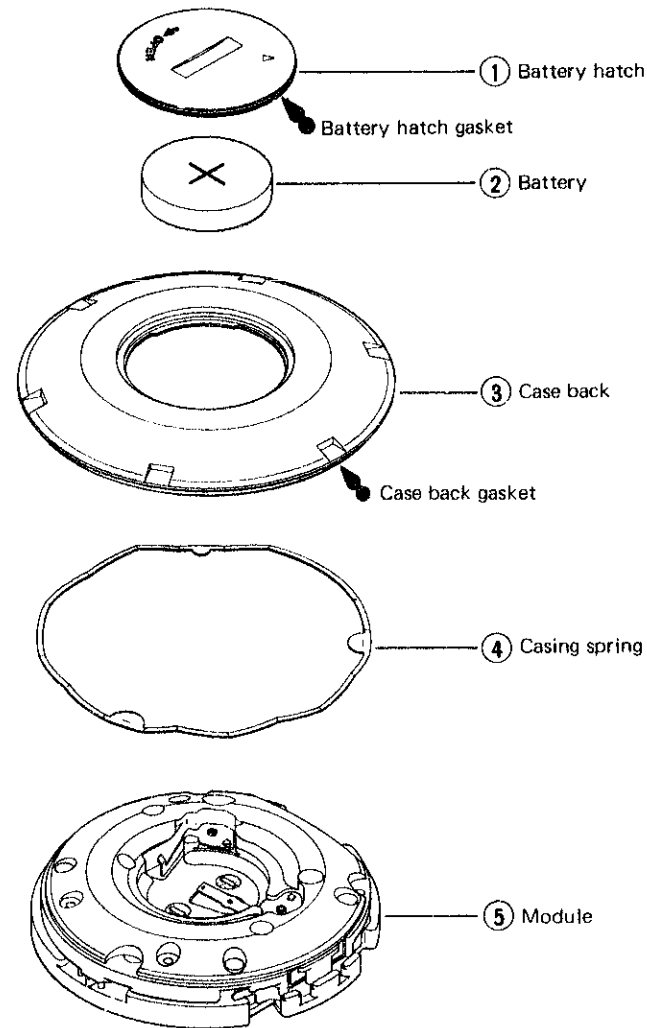
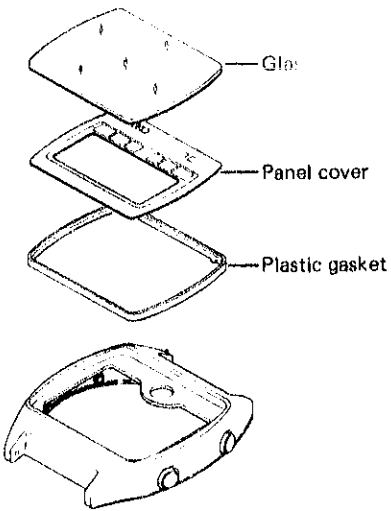

(Hook-up for time adjusting button)  
(Time adjusting button)

Hole for correct positioning of module

⑥ Casebezel

It is not necessary to disassemble the time adjusting buttons and hook-ups for time adjusting buttons (4 assemblies) except when they are required to be replaced.

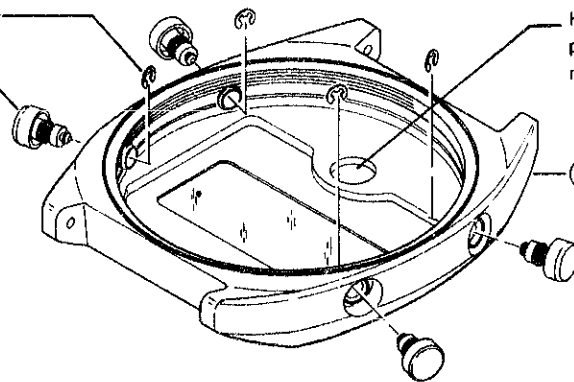

#### Remarks for disassembling

##### ⑤ Module

- As the liquid crystal panel frame is fixed fast to the casebezel, pry it up with tweezers and remove the module.

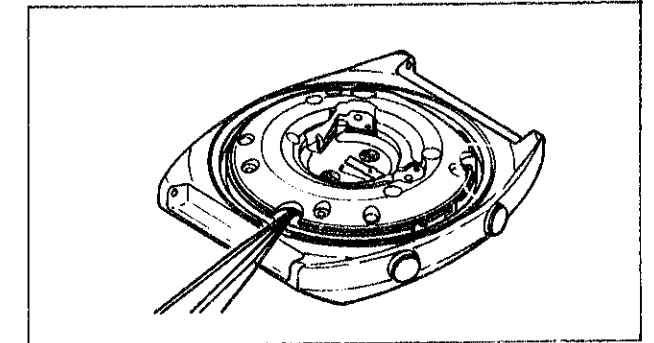

#### Remarks for reassembling

##### ⑥ Casebezel

- Before reassembling the module, pull out all buttons so that the switch springs do not prevent the module from being reassembled. (Push the buttons from inside with the tips of tweezers.)

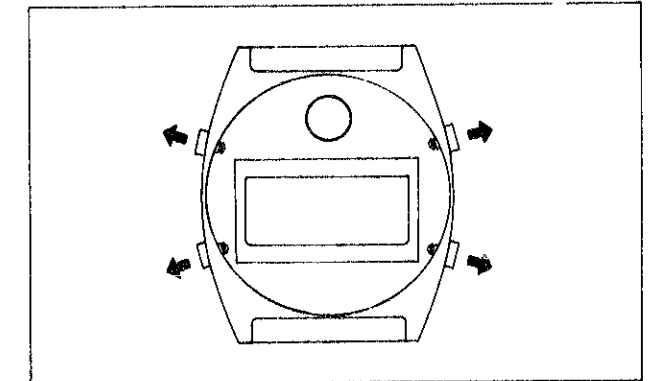

##### ⑤ Module

- As the liquid crystal panel frame is fixed fast to the casebezel, push in the module with fingers.
- Push it in so that it does not catch the buttons.

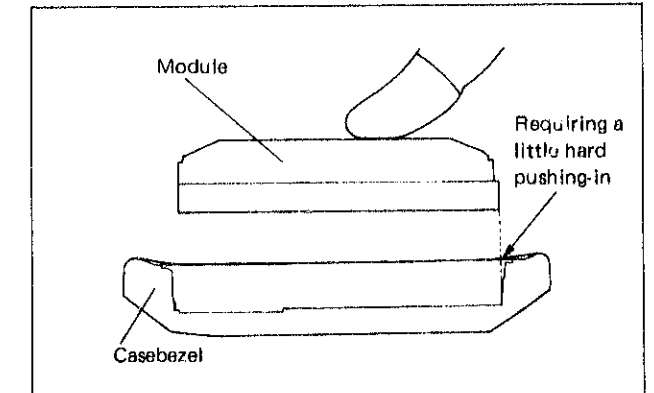

##### ④ Casing spring

- Set the casing spring as shown in the illustration on the right with the upper side and the lower side placed correctly. (There are three protrusions on the casing spring; two of which are larger and one is smaller. Be sure to fit each of them correctly to the corresponding notches of the module.)

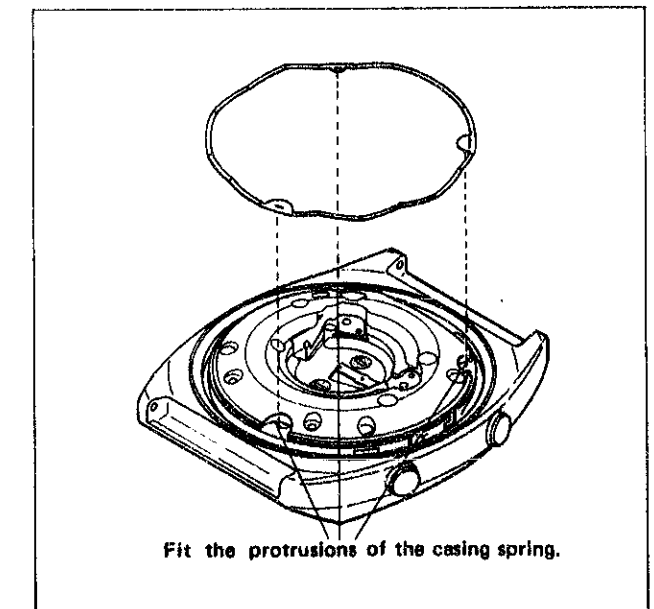

### How to replace the glass

(Do not disassemble the glass except when the replacement of the glass and the panel cover is necessary.)

#### • How to disassemble the glass

- Remove the glass with the SEIKO tightening tool S-220.  
Inserting disk: S-162  
Supporting disk:  $\phi 34.0 \sim \phi 35.0$  mm
- Place a vinyl sheet between the glass and the supporting disk as shown in the illustration on the right.
- Push only the glass for disassembling with the inserting disk (S-162). Do not push the panel cover.

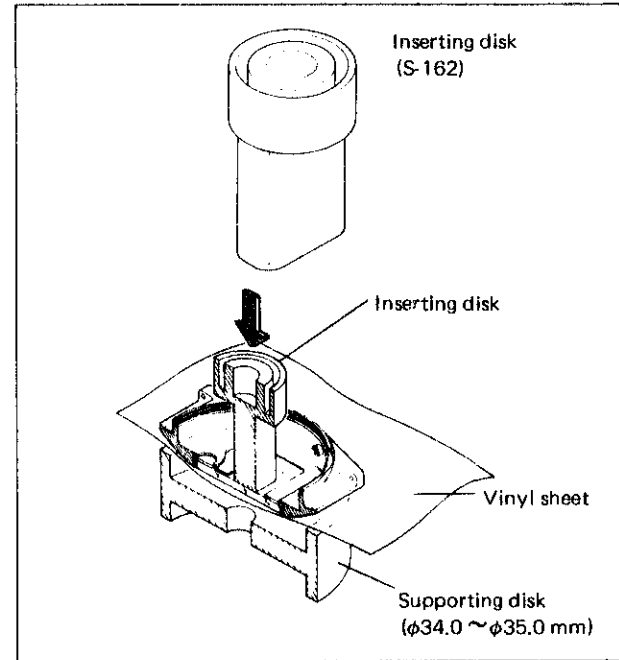

#### • How to reassemble the glass

- Set the plastic gasket.
  - Be sure to replace the plastic gasket with a new one.
  - Be careful not to mistake the upper side for the lower side.
- Reassemble the panel cover.
  - Be sure to set the backside of the panel cover fast to the casebezel.
  - Be sure that the space between the casebezel and the edge of the panel cover is uniform in width.
- Place the glass.
  - Be careful not to mistake the upper side for the lower side. Place the round side down.
- Push in the glass (by using S-220).  
Inserting disk: Plastic supporting disk (S-173)  
Supporting disk:  $\phi 28.0$  or  $\phi 28.5$  mm

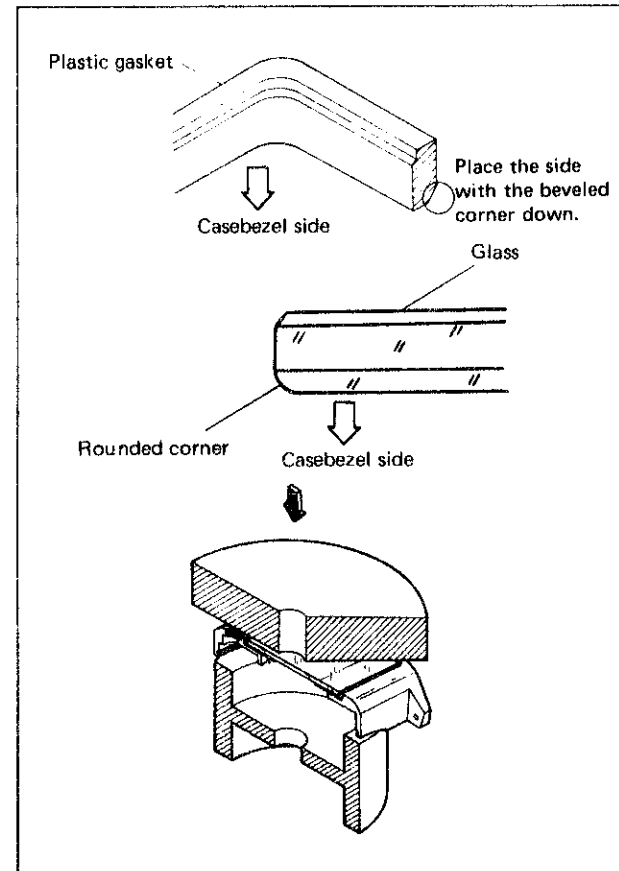

Some models are reassembled in the order of ① panel cover, ② plastic gasket. See the SEIKO Watch Casing Guide for details.

Ex.) Case No. A127-5019 A3

## 2. Disassembling and reassembling of the module

Disassembling procedures Figs.: ① ~ ⑧

Reassembling procedures Figs.: ⑧ ~ ①

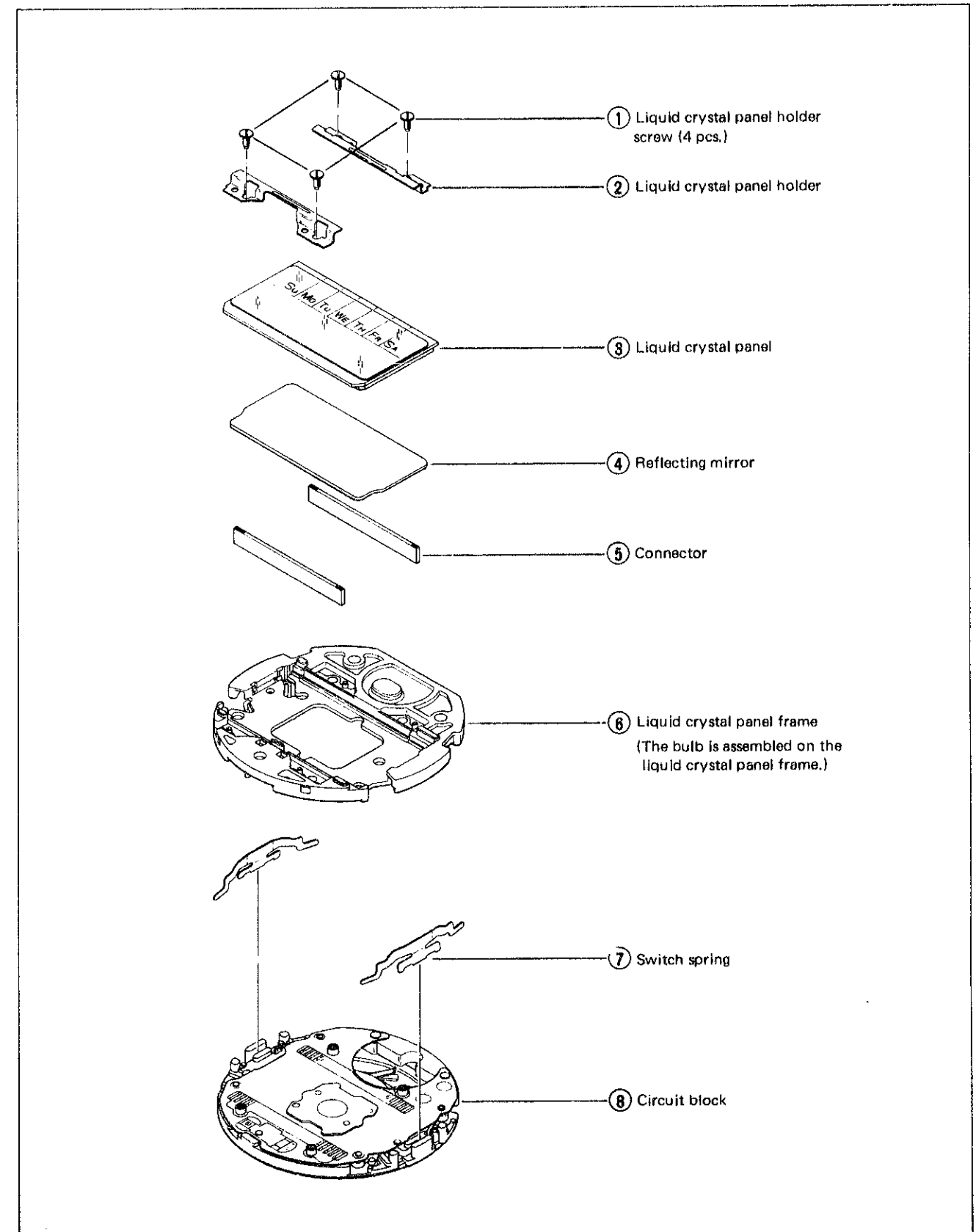

*Remarks for disassembling*

④ **Reflecting mirror**

- Be careful not to scratch or contaminate the reflecting mirror.

⑤ **Connector**

- The connectors may be disassembled together with the liquid crystal panel.
- Be careful not to scratch the connectors with tweezers.
- There is no difference between the connectors in the top and bottom.

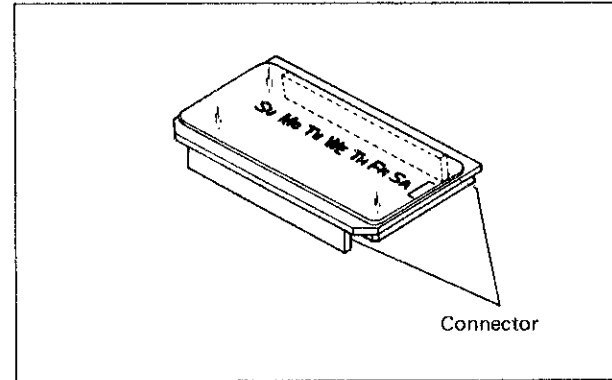

⑧ **Circuit block**

- Be careful not to touch the electronic parts except when it is necessary.

*Remarks for reassembling*

⑦ **Switch spring**

- Set the switch spring in position vertically from above.
- Push it in by the flat part of the end of the tweezers.

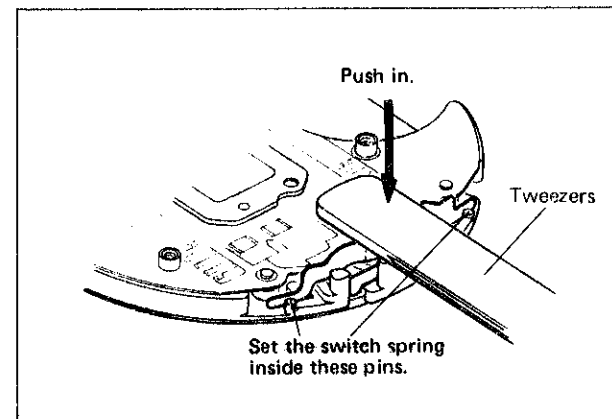



1. Guide table for checking and adjustment

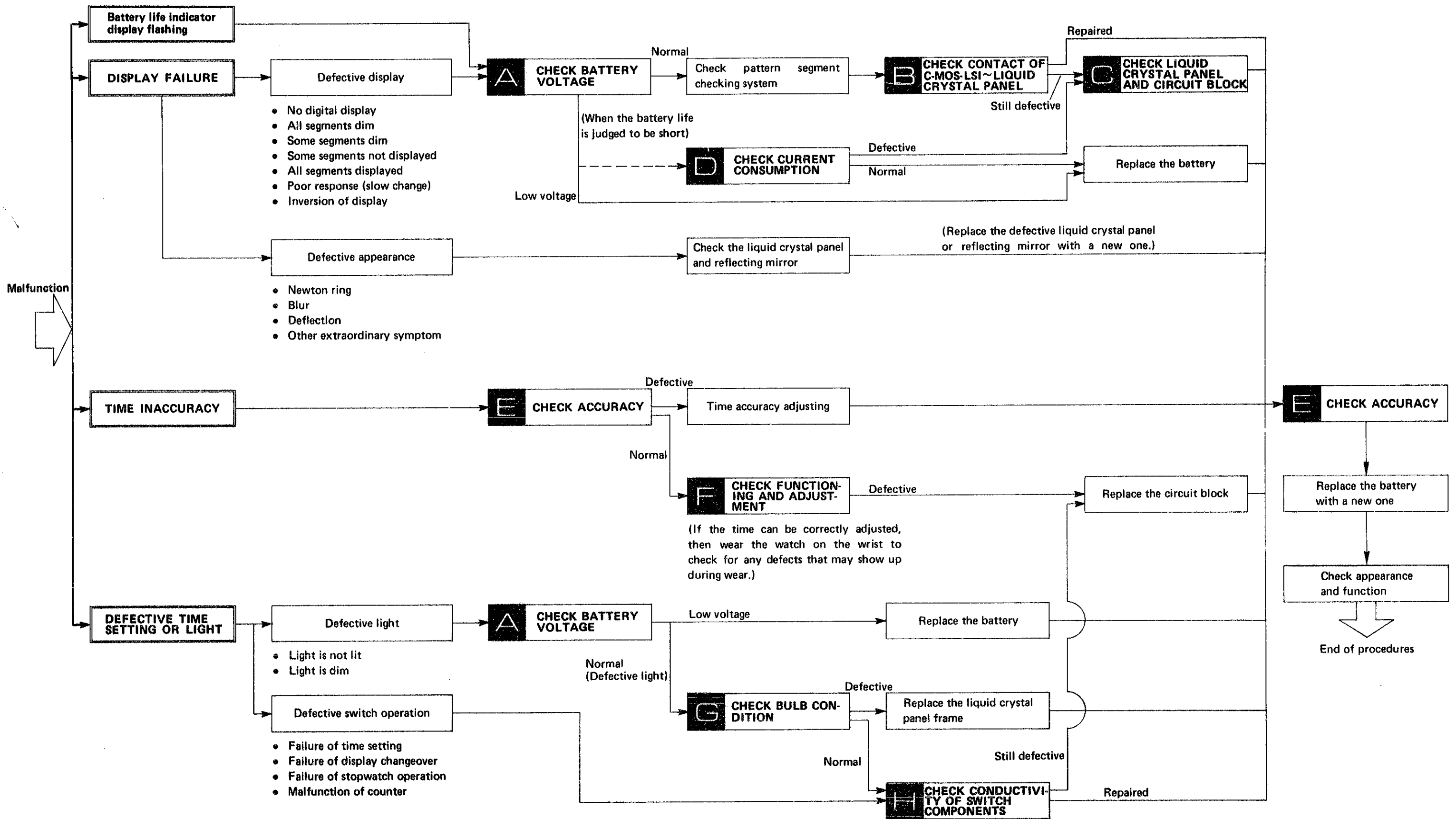

## 2. Relationship between the segment (Liquid Crystal Panel Electrode) and the C-MOS-LSI output terminal

A complete knowledge of how the segment (Liquid Crystal Panel Electrode) works with the C-MOS-LSI output terminal will provide the proper procedures for checking and adjustment.

### • Designation of segment

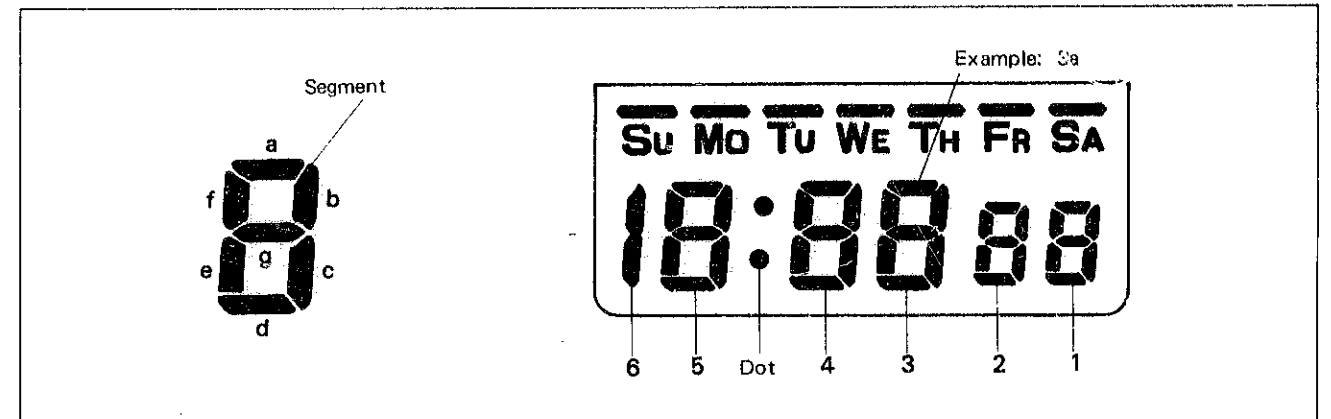

### • Relationship between the segment and the C-MOS-LSI output terminal

The liquid crystal panel electrode is connected electrically with each segment which forms a digital figure as shown in the illustration of the panel pattern below.

(The panel pattern can be seen if the panel is slightly tilted and looked at in an angular position.) Also, the liquid crystal panel electrode is connected electrically with the C-MOS-LSI output terminal by the connector.

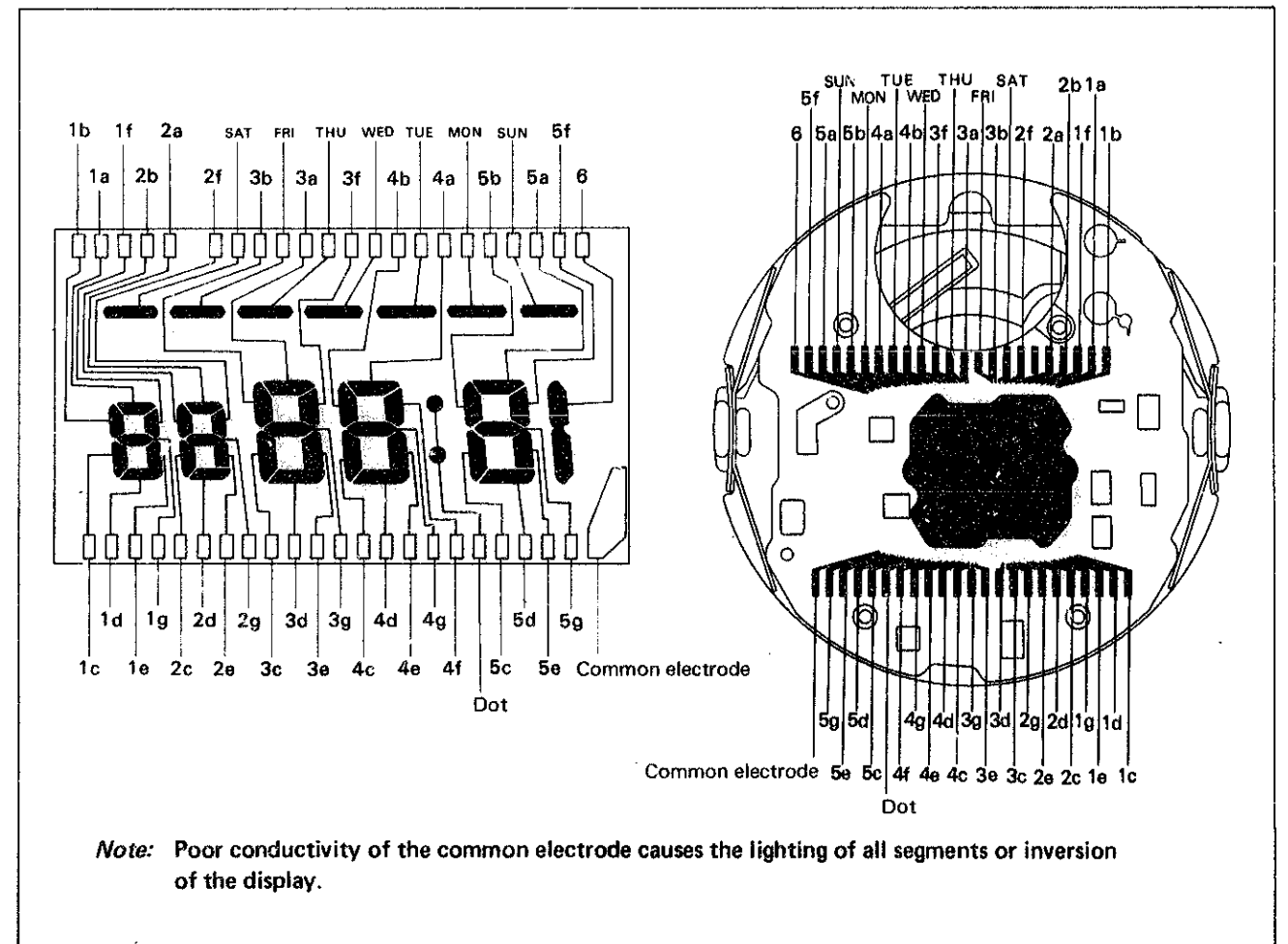

### III. CHECKING AND ADJUSTMENT

Be sure to use the static electricity protector (S-836) when handling the module.

#### 1. Guide table for checking and adjustment

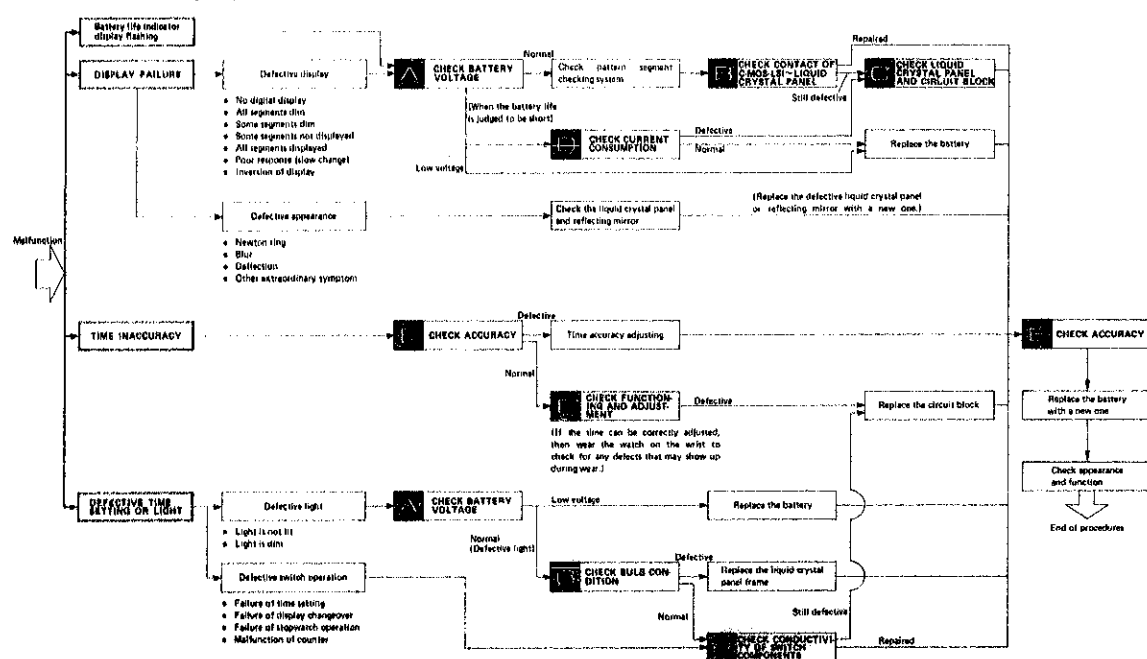

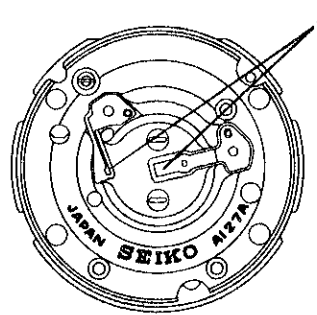

### 3. Procedures for checking and adjustment

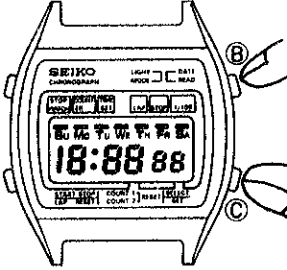
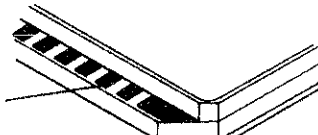
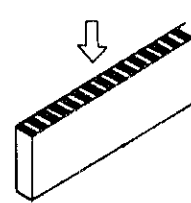
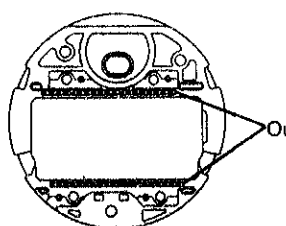
	Procedures	Result and repair
CHECK BATTERY VOLTAGE	<p>Check battery voltage.</p> <div style="border: 1px solid black; padding: 5px; margin: 10px 0;"> <p>When there is battery electrolyte leakage, refer to "HOW TO CHECK BATTERY ELECTROLYTE LEAKAGE AND REPAIR" below for repairing.</p> </div>	<p>More than 1.5V ... Normal Less than 1.5V ... Defective</p>
HOW TO CHECK BATTERY ELECTROLYTE LEAKAGE AND REPAIR	<p>(1) Remove the module from the case. (2) Disassemble the module. (3) Wipe off battery electrolyte on the circuit block.</p> <p>1. Wipe off battery electrolyte with a cloth moistened with distilled water. If distilled water is not available, use tap water.</p> <div style="border: 1px solid black; padding: 5px; margin: 10px 0;"> <p><i>Note:</i></p> <ul style="list-style-type: none"> <li>• Do not expose the trimmer condenser to water or alcohol, and if it is exposed, there may be a change in the condenser capacity and eventually in the time accuracy.</li> <li>• Do not use a cloth which gives off lint, such as gauze, flannel, etc.</li> </ul> </div> <p>○ When the circuit block is cleaned, be sure to clean the connecting portions.</p> <div style="display: flex; align-items: center; margin: 10px 0;">  <div style="margin-left: 10px;"> <p>If the circuit block is badly contaminated with battery electrolyte, replace the circuit block with a new one.</p> <p>Ex.</p> <ul style="list-style-type: none"> <li>• When the circuit block is rusted.</li> <li>• When even the liquid crystal panel side is contaminated with battery electrolyte.</li> </ul> </div> </div> <p>2. Rinse with alcohol. (If the cleaned portions remain wet with water, they will corrode with rust.) 3. Dry with warm air by using a dryer.</p> <p>(4) Clean the other parts (switch spring, etc.).</p> <p>1. Wipe off battery electrolyte on each part with a soft brush moistened with distilled water. If distilled water is not available, use tap water. 2. Rinse with alcohol. 3. Dry with warm air by using a dryer.</p> <p>(5) Reassemble the module. Replace the battery with a new one.</p> <p>(6) Check to see if the time and calendar function, the stopwatch function, the calendar function and the current consumption are normal.</p>	

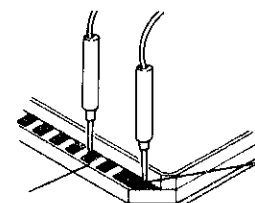
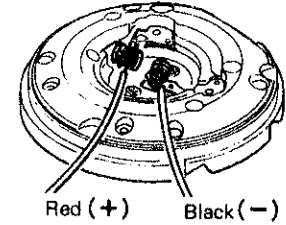
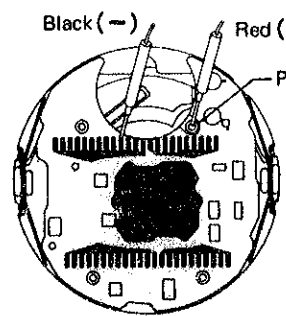
	Procedures	Result and repair
CHECK PATTERN SEGMENT CHECKING SYSTEM	<p>If some segments are dead or dim, set the mode for the time and calendar setting function. Then depress buttons <b>B</b> and <b>C</b> together to find defective segments. (If there is no defective segment, all segments light up.)</p> 	<p>Proceed to <b>B</b>.</p>
CHECK CONTACT OF C-MOS-LSI~LIQUID CRYSTAL PANEL	<p>After removing the liquid crystal panel, check for poor conductivity of the liquid crystal panel, connector and C-MOS-LSI output terminal whose segments are found to be defective in "CHECK PATTERN SEGMENT CHECKING SYSTEM." (Refer to the "Relationship between the segment and the C-MOS-LSI output terminal" on page 8.) Use a microscope for checking.</p> <p>(1) Check for dust, lint and other contamination on the liquid crystal panel electrode.</p>  <p>Liquid crystal panel electrode</p> <p>(2) Check for any contamination, scratch, crack and break of the connector.</p>  <p>Be sure to check the connecting portions of the liquid crystal panel and the circuit block carefully.</p> <p>(3) Check for dust, lint and other contamination on the output terminal of the circuit block.</p>  <p>Output terminal of the circuit block</p>	<p>Uncontaminated: Normal Proceed to <b>B</b> (2). Contaminated: Defective Wipe off any foreign matter.</p> <p>No contamination, scratch, crack or break: Normal Proceed to <b>B</b> (3). Contaminated: Defective Clean off. Scratched, cracked or broken: Defective Replace the connector with a new one.</p> <p>Uncontaminated: Normal Proceed to <b>B</b>. Contaminated: Defective Wipe off any foreign matter.</p>

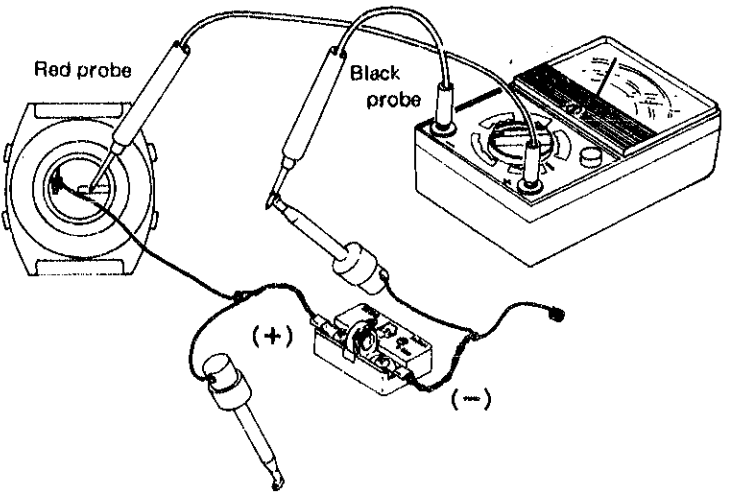
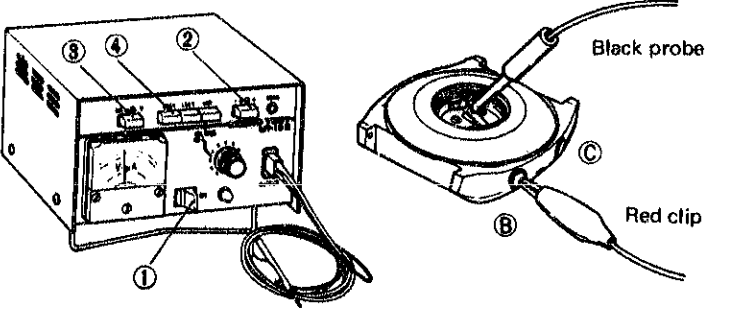
	Procedures	Result and repair
CHECK LIQUID CRYSTAL PANEL AND CIRCUIT BLOCK	<p>Check to see if the liquid crystal panel and the circuit block function correctly. (Refer to the "Relationship between the segment and the C-MOS-LSI output terminal" on page 8.)</p> <p>(1) Check liquid crystal panel.</p> <ol style="list-style-type: none"> <li>Set up the volt-ohm-meter. Range to be used: OHMS R x 1 ~ R x 1K</li> </ol> <div style="border: 1px solid black; padding: 5px; margin: 10px 0;"> <p><i>Note:</i> Any range will do if more than 3V is applied to the terminal of the volt-ohm-meter. When the volt-ohm-meter other than the SEIKO volt-ohm-meter S-831 is used, all segments may not be lit. If any segment does not light, change the range to the one (R x 10K) which is higher in resistance than R x 1K.</p> </div> <ol style="list-style-type: none"> <li>Remove the liquid crystal panel from the module and turn it upside down.</li> <li>Measuring (Check to see if the corresponding segment lights up.)</li> </ol>  <p><i>Note:</i> Either red or black probe will do.</p> <p>Common electrode (Either red or black probe must be applied to the common electrode.)</p> <p>Electrode of defective segment</p> <p>(2) Check the circuit block output voltage.</p> <ol style="list-style-type: none"> <li>Set up the Volt-ohm-meter. Range to be used: DC 3 V</li> <li>Attach the electricity supplier (S-833) to the circuit block. Spring (+): Plus terminal of battery connection Spring (-): Battery connection</li> <li>Measuring Probe Red (+): Pin for the liquid crystal panel holder screw of the circuit block (Shown in the right illustration.) Probe Black (-): Each portion of the output terminal of the C-MOS-LSI. (If some displays are defective, apply to the corresponding output terminals of the C-MOS-LSI.)</li> </ol>  <p>Red (+) Black (-)</p>  <p>Black (-) Red (+) Pin</p>	<p>Lights up: Normal Proceed to <b>B</b> (2). Does not light up: Defective Replace the liquid crystal panel with a new one.</p> <p>More than 0.8V: Normal (All the terminals must be more than this range of voltage.) Return to <b>B</b>. Less than 0.8V: Defective Replace the circuit block with a new one and check to see if it functions correctly.</p>

	Procedures	Result and repair
<b>CHECK CURRENT CONSUMPTION</b>	<p>Check to see if the current consumption is normal. (Can be checked no matter which function the watch may be performing.)</p> <ul style="list-style-type: none"> <li>Set up the volt-ohm-meter. Range to be used: DC 12<math>\mu</math>A (DC 0.03 mA)* Use the electricity supplier (S-833) and connect as shown in the illustration below.</li> </ul>  <ul style="list-style-type: none"> <li>Micro Test MT-10 II*.           <ol style="list-style-type: none"> <li>Power switch . . . ON</li> <li>Polarity changeover button: +</li> <li>Current consumption/ Voltage indication button: <math>\mu</math>A</li> <li>Voltage selection button: 1.55V Proba Black (+): Battery connection Clip Red (-): Button (except the light button)</li> </ol> </li> </ul>  <p>Apply the red clip (+) to the button B or button C for measuring.</p> <p style="border: 1px solid black; padding: 2px; display: inline-block;">Be careful not to depress the buttons while measuring.</p>	<p><i>*Note:</i> If the pointer of the volt-ohm-meter swings over the maximum value when DC 12<math>\mu</math>A (DC 0.03 mA) is used, change the range to a greater one where the pointer does not run over the maximum value while applying the probes to the respective portions. Then, after two or three seconds, return the range to DC 12<math>\mu</math>A (DC 0.03 mA) again for measuring.</p> <p>Less than 3.0<math>\mu</math>A: Normal Replace the battery with a new one. More than 3.0<math>\mu</math>A: Defective Proceed to .</p> <p><i>*Note:</i> If the pointer of the Micro Test MT-10 II swings over the maximum value while the current consumption is measured, depress the Current consumption/Voltage indication button (3) so that it is released to indicate the voltage (1.55 V) while the black probe and the red clip are applied. Then, after two or three seconds, depress the Current consumption/Voltage indication button again so that it holds in the pushed in position (<math>\mu</math>A) to indicate the current consumption for measuring.</p>

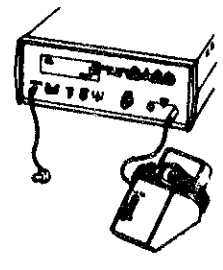
	Procedures	Result and repair
<b>CHECK ACCURACY</b>	<p>Check gain and loss of time.</p> <ol style="list-style-type: none"> <li>Set up the Quartz Tester.</li> <li>Measuring</li> </ol> 	<p>Does not lose or gain: Normal Proceed to the following procedure. Loses or gains: Defective Proceed to <u>Time accuracy adjusting.</u> Time accuracy is adjusted by turning the trimmer condenser.</p>
<b>CHECK FUNCTIONING AND ADJUSTMENT</b>	<p>Check to see if the watch functions correctly and can be adjusted by the button operation.</p> <ol style="list-style-type: none"> <li>Check the stopwatch function.           <ul style="list-style-type: none"> <li>Check to see if "start", "stop", "lap", "lap release" and "reset" function correctly.</li> </ul> </li> <li>Check the counter function.           <ul style="list-style-type: none"> <li>Check to see if seconds can be counted correctly or can be reset to "00" second.</li> </ul> </li> <li>Check the time and calendar setting function.           <ul style="list-style-type: none"> <li>Set the time and calendar digits more than one cycle for each unit and check to see if each digit is advancing correctly.</li> </ul> </li> </ol>	<p>Functions correctly and can be adjusted: Normal Wear the watch on the wrist to check time accuracy. Does not function correctly or cannot be adjusted: Defective Proceed to <u>Replace the circuit block.</u></p>

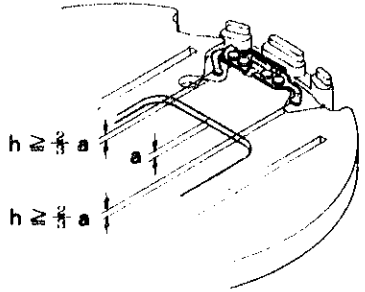
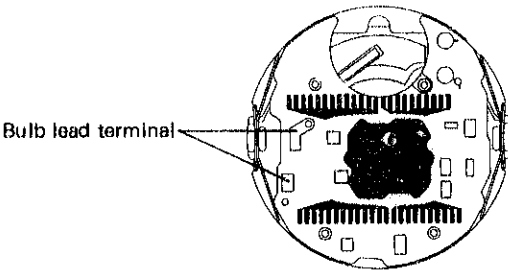
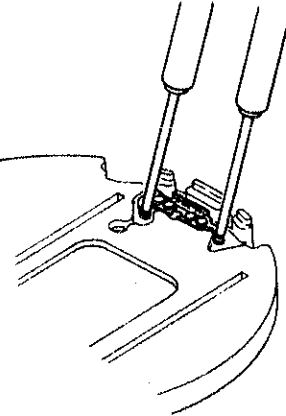
	Procedures	Result and repair
<b>G</b>	<p>(1) Check to see if the bulb lead terminals touch the lead terminal of the circuit block.</p> <p>1. Check to see if the two bulb lead terminals protrude by more than 0.3mm from the backside of the liquid crystal panel frame. And check for any dust, lint and other contamination of the bulb lead terminal.</p>  <p>Protrusion "h" of the bulb lead terminal should be two-thirds or more of the thickness "a" of the liquid crystal panel frame.</p> <p>2. Check for any contamination on the bulb lead terminal of the circuit block.</p>  <p>Bulb lead terminal</p> <p>(2) Check to see if there is a broken filament in the bulb and if there is any break in the welded portion of the bulb lead terminal.</p> <p>1. Set up the volt-ohm-meter. Range to be used: OHMS R x 1</p> <p>2. Measuring Apply the two probes of the volt-ohm-meter to the bulb lead terminals as shown in the illustration.</p>  <p><b>Note:</b> Either red or black probe will do.</p>	<p>Protrude by more than 0.3mm: Normal Protrude by less than 0.3mm: Defective Pull out by using tweezers.</p> <p>No dust, lint or uncontaminated: Normal Proceed to <b>G</b> (2). Dust, lint or contaminated: Defective Wipe off any foreign matter.</p> <p>Bulb lights up: Normal Proceed to <b>I</b>. Bulb does not light up: Defective Proceed to <u>Replace the liquid crystal panel frame.</u></p>

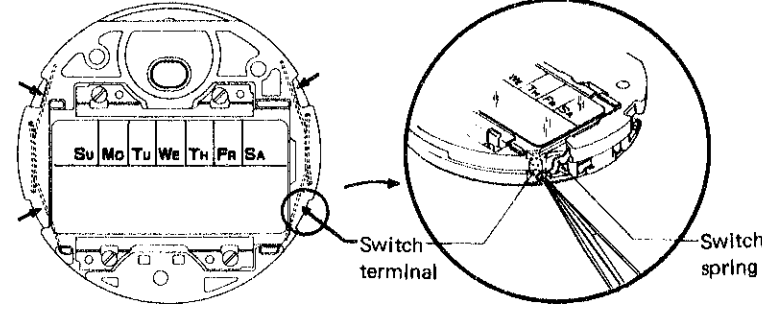
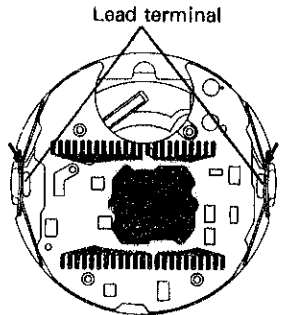
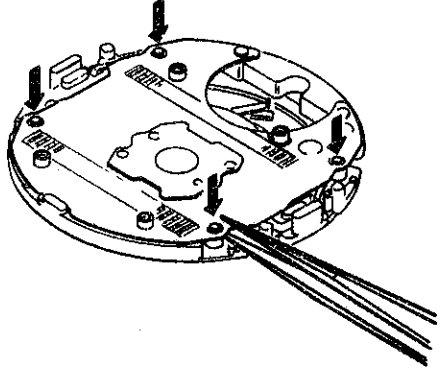
	Procedures	Result and repair
<b>I</b>	<p>Check to see if the switch spring functions correctly.</p> <p>(1) Check to see if the switch springs (four arrow-marked portions shown in the illustration below) function correctly when they are pushed in.</p> <p>1. Check to see if the four arrow-marked springs touch the switch terminals of the circuit block when they are pushed in with the tips of tweezers and that they do not touch the switch terminals of the circuit block when released.</p>  <p>2. Check for dust, lint and other contamination on the contacting portions.</p> <p>(2) Check to see if the lead terminal of the switch spring touches the lead terminal of the circuit block.</p> <p>1. Check to see if the two arrow-marked portions touch correctly when the liquid crystal panel frame is disassembled.</p>  <p>Lead terminal</p> <p>2. Check for dust, lint and other contamination on the connecting portions.</p> <p>(3) Check to see if the pins for the switch terminals are fixed firmly in the circuit board. Check to see if the four arrow-marked pins for the switch terminals are fixed firmly in the circuit board by slightly lifting the circuit board with tweezers as shown in the illustration on the right.</p> 	<p>Functions correctly: Normal Does not function correctly: Defective</p> <p>If the switch springs do not function correctly after they are adjusted, replace them with new ones.</p> <p>No dust, lint or uncontaminated: Normal Proceed to <b>I</b> (2). Dust, lint or contaminated: Defective Wipe off any foreign matter.</p> <p>Touch: Normal Do not touch: Defective Adjust by using tweezers so that the lead terminal of the circuit block touches the switch spring.</p> <p>No dust, lint or uncontaminated: Normal Proceed to <b>I</b> (3). Dust, lint or contaminated: Defective Wipe off any foreign matter.</p> <p>Fixed firmly: Normal Proceed to Replace the circuit block. (Defective C-MOS-LSI) Not fixed firmly: Defective Replace the circuit block. (The pins for the switch terminals are not fixed firmly.)</p>